

Ocean Observations Solutions

- Long term in-situ ocean observation
 - Multi-parameter and UV- biofouling control
- Vessel-mounted mobile real-time observation
 - Moving Vessel Profiler (MVP)

Challenges for long-term in-situ deployment

- Balancing the need for multi-discipline data
- Successful deployment multi instruments and hundred sensors in harsh ocean environment
- High cost both scheduled and un-scheduled maintenance
- sensor drift from bio-fouling and/or not calibrate sensors
- Environmentally friendly

Long term in-situ deployment and bio-fouling Case Studies



Bio fouling development stages

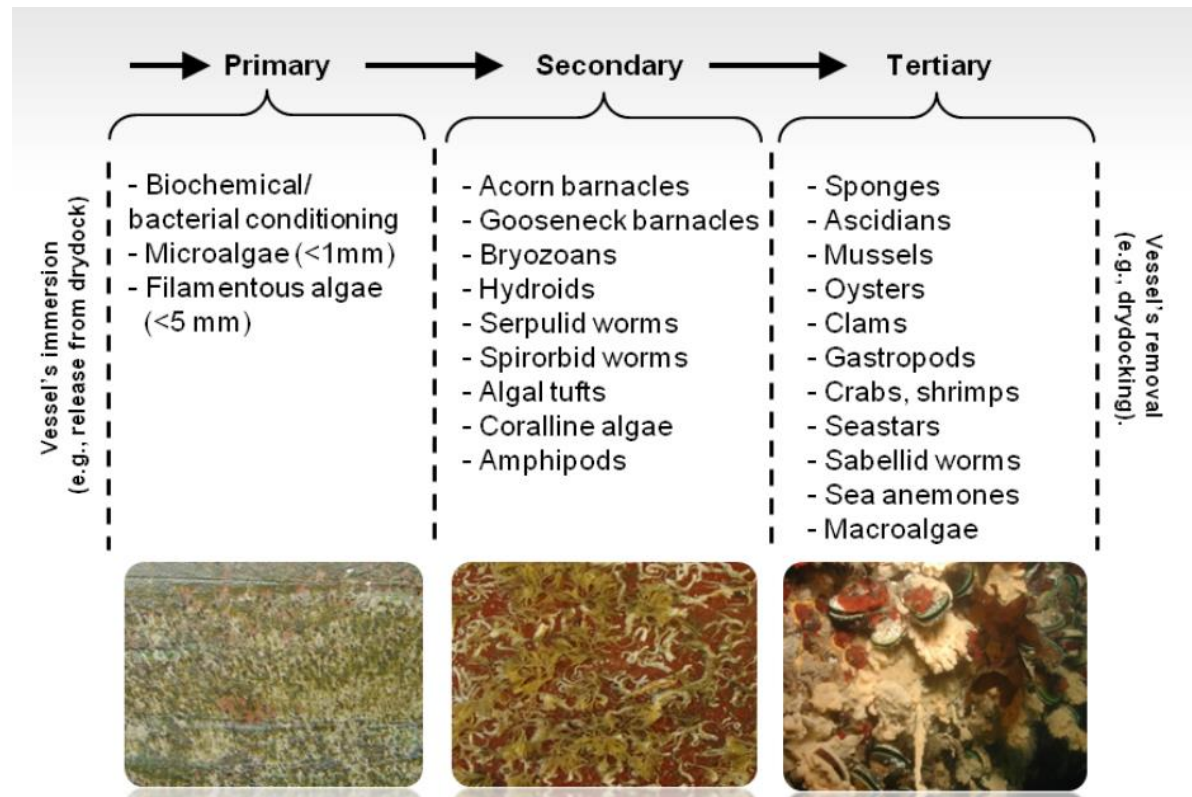

Bio-fouling distribution

- **Polar zones** $< 5^{\circ}\text{C}$, low fouling risk. Fouling will occur for a short time typically either side of summer. Global warming, Norway has an usual hot summer reaching 30°C this year.
- **Temperate zones:** $5\text{-}20^{\circ}\text{C}$, medium fouling risk. Fouling will occur throughout the year peaking in spring to early autumn.
- **Tropical/subtropical zones:** $20^{\circ}\text{C}+$, high fouling risk. Fouling risk is high through out the year with a multiplicity of species.

Currently Available Technologies

Method	Embodiment	Comment
Mechanical	Wipers, brushes, water jets, etc.	<ul style="list-style-type: none"> • Generally works alright when in good shape • Cannot be used on complicated geometry, may damage some sensors, etc. • Mechanically complex, prone to failure.
Surface treatments	Copper cladding, poisonous paints, non-stick coatings	<ul style="list-style-type: none"> • Cannot be used to protect sensor components, more suitable for ship hulls, etc. • Copper is the only embodiment typically used
Chemical dosing	Volumetric dosing with TBT, chlorine, copper ion, etc.	<ul style="list-style-type: none"> • TBT has been banned since 2003 • Used by special permission only

SeaBird: Current gold standard for in-situ biofouling protection. Use TBT pumping system.

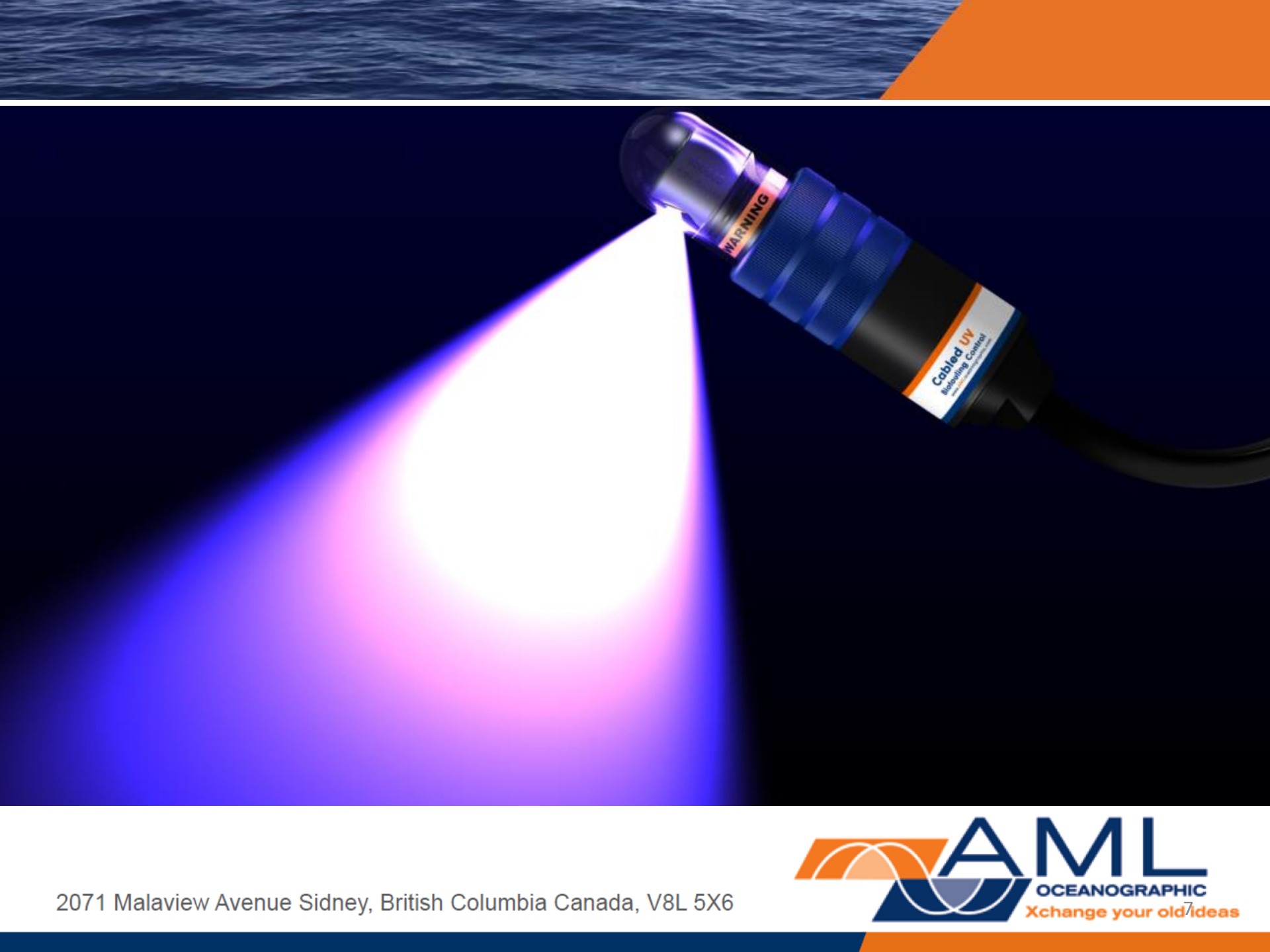

2071 Malaview Avenue Sidney, British Columbia Canada, V8L 5X6



What Is UV•Xchange?

- An Xchange form fit device used to protect surfaces from biofouling using Ultra Violet Light (UV)
- Utilized as a stand alone device or with an AML X•Series CTD Configuration



Cabled UV Biofouling Control



- Protect any surface
- Use one or multiple LED modules on one cable
- Effective anti fouling seen up to 45 cm away
- Power required:
 - 12-26 volt DC
 - 30 mA (low power LED module)
 - 80 mA (high power LED module)
- Recommended duty cycle 25% - 50% LED on-time
 - Duty Cycle Controller available separately
- LED effective life 1 – 2 years
 - User replaceable

UV antifouling is unlike

- TBT and other chemical dosing methods which are banned in many countries due to their harmful environmental impact
- Copper tape and other antifoulant coatings, which are not suitable for complex and fragile sensing surfaces, and have a limited life span
- Mechanical wipers which are prone to malfunction and fouling themselves and are unsuitable for sensitive optical lenses and complex geometric surfaces
- Chemical pumps which produce acoustic noise that can be picked by hydrophones
- All biofouling control methods on the market, which require direct contact with target surfaces. UV antibiofouling has protected critical surfaces up to 50cm away.

AML UV-biofouling applications

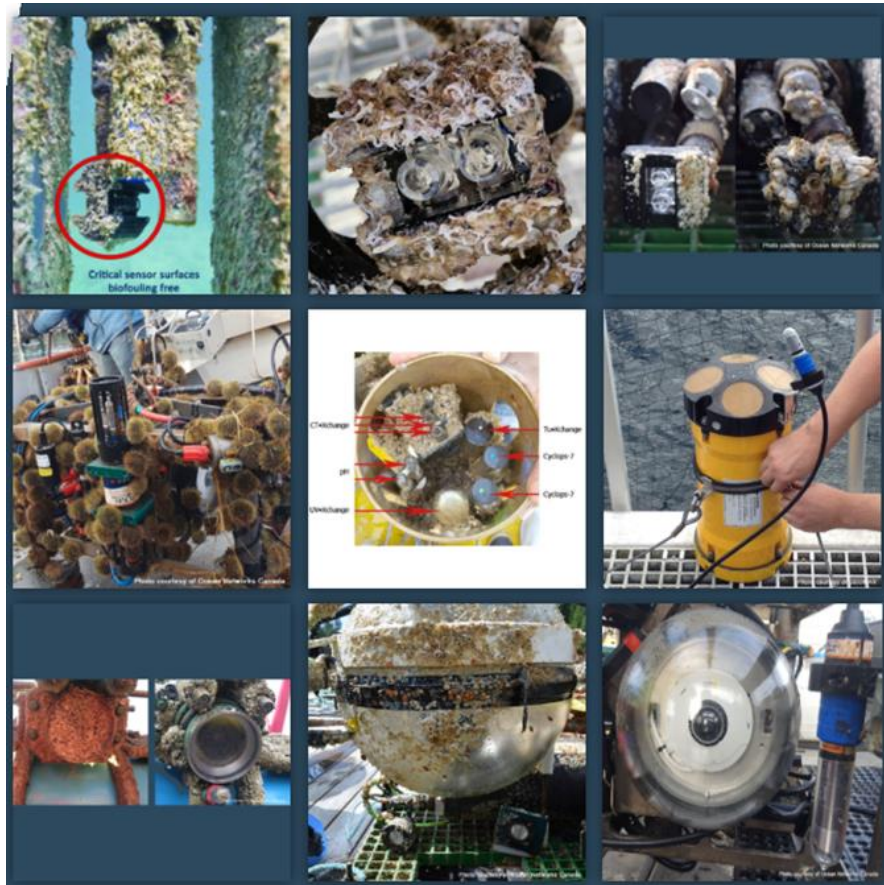

AML biofouling solutions

AML's UV Biofouling Control is proven to remove both the technical and financial unpredictability brought on by biofouling during in-situ deployments.

☑ **Sensors**

☑ **ADCPs**

☑ **Camera Lenses**

☑ **Lights**

☑ **Hydrophones**

☑ **Sonar Heads**

With hundreds of devices deployed around the world, AML's UV•Xchange and Cabled UV are the market leaders in biofouling control technologies.

Case1 - Ocean Networks Canada

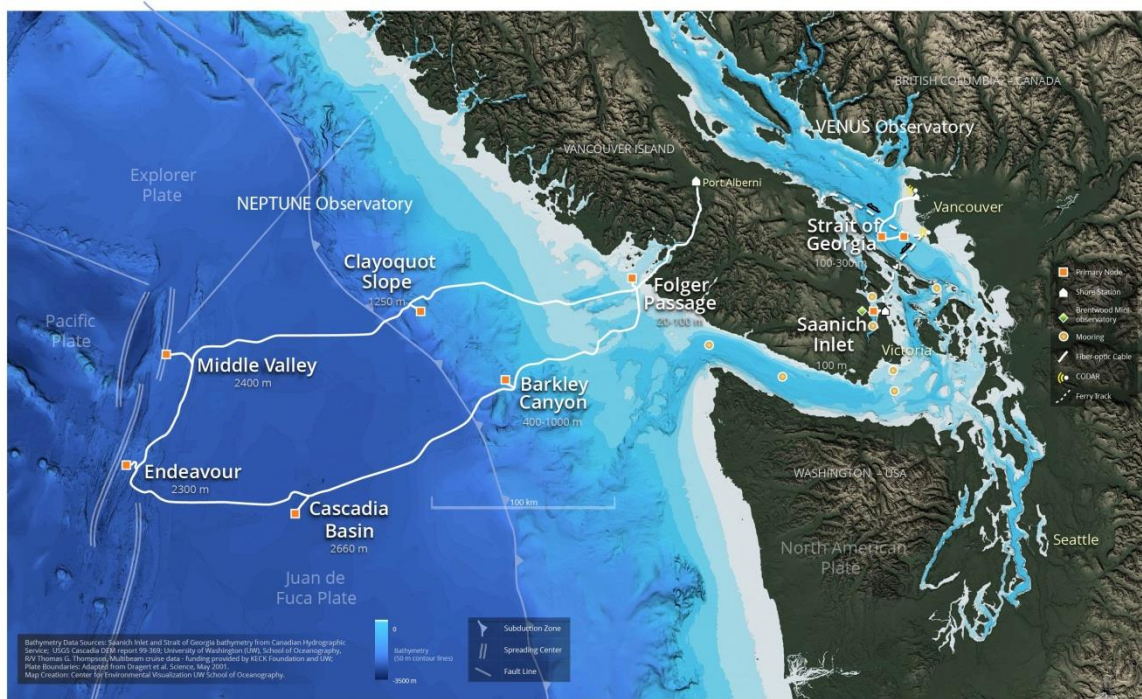

- Largest cabled ocean observing system in the world
- 200 instruments streaming data 24/7
- 1 TB of data every 4 days

Foul Free for over Two Years

Presentation of results from AML
Oceanographic UV Xchange biofouling
control experiment at Folger Pinnacle

Deployment Site

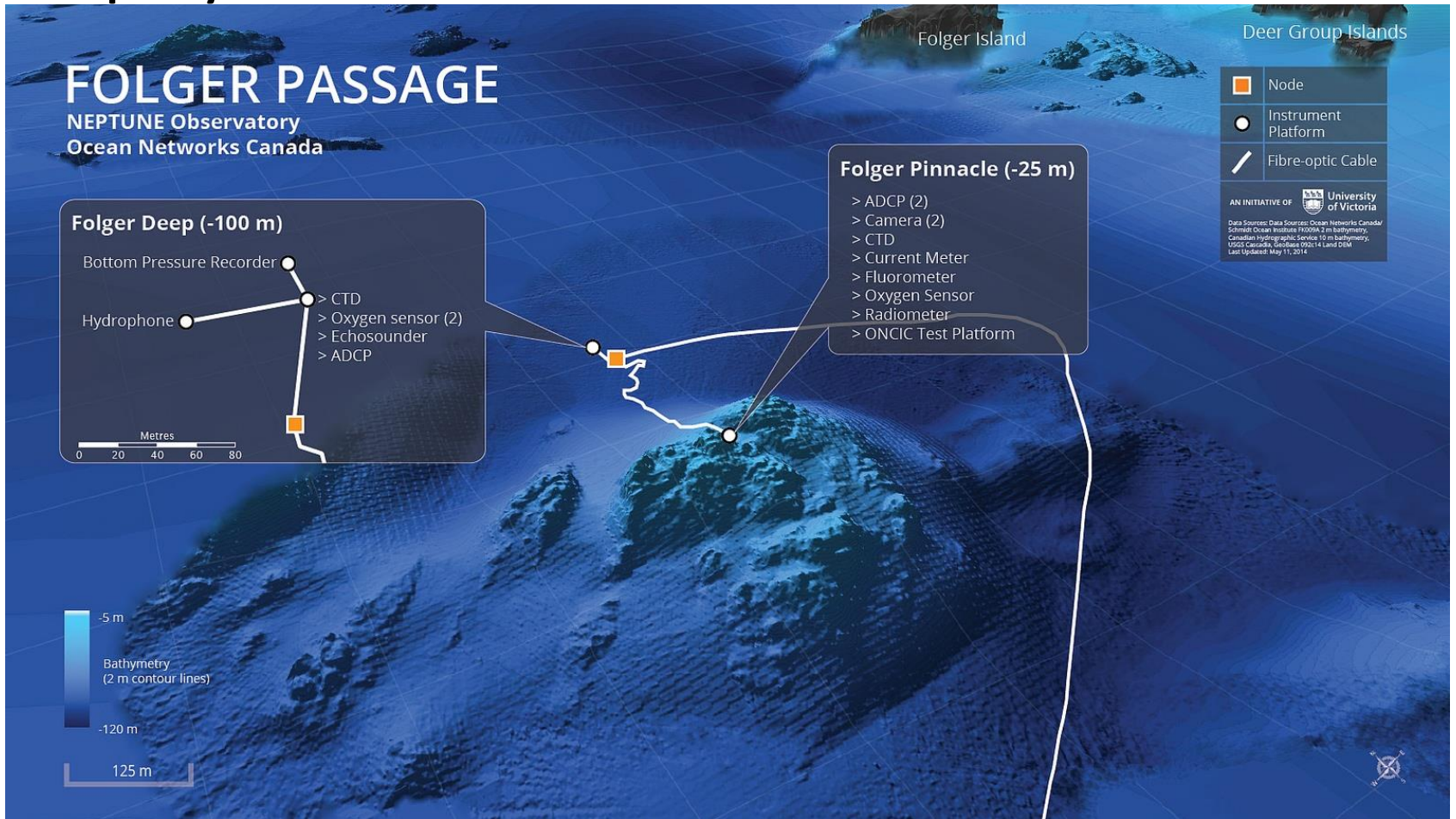

Marine life and biofouling at Folger Pinnacle

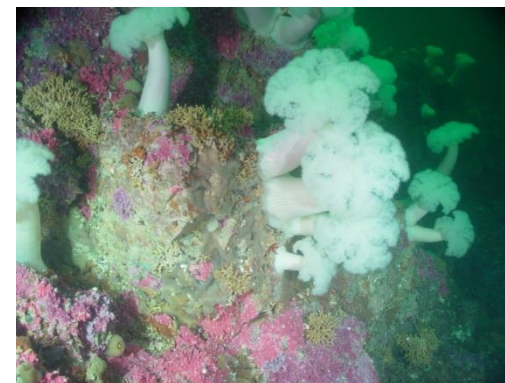
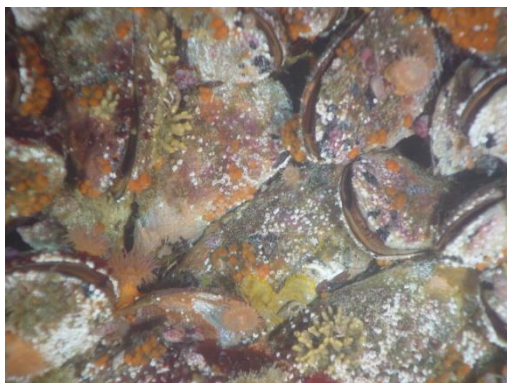

2071 Malaview Avenue Sidney, British Columbia Canada, V8L 5X6



UV experiment module at Folger Pinnacle September 2013

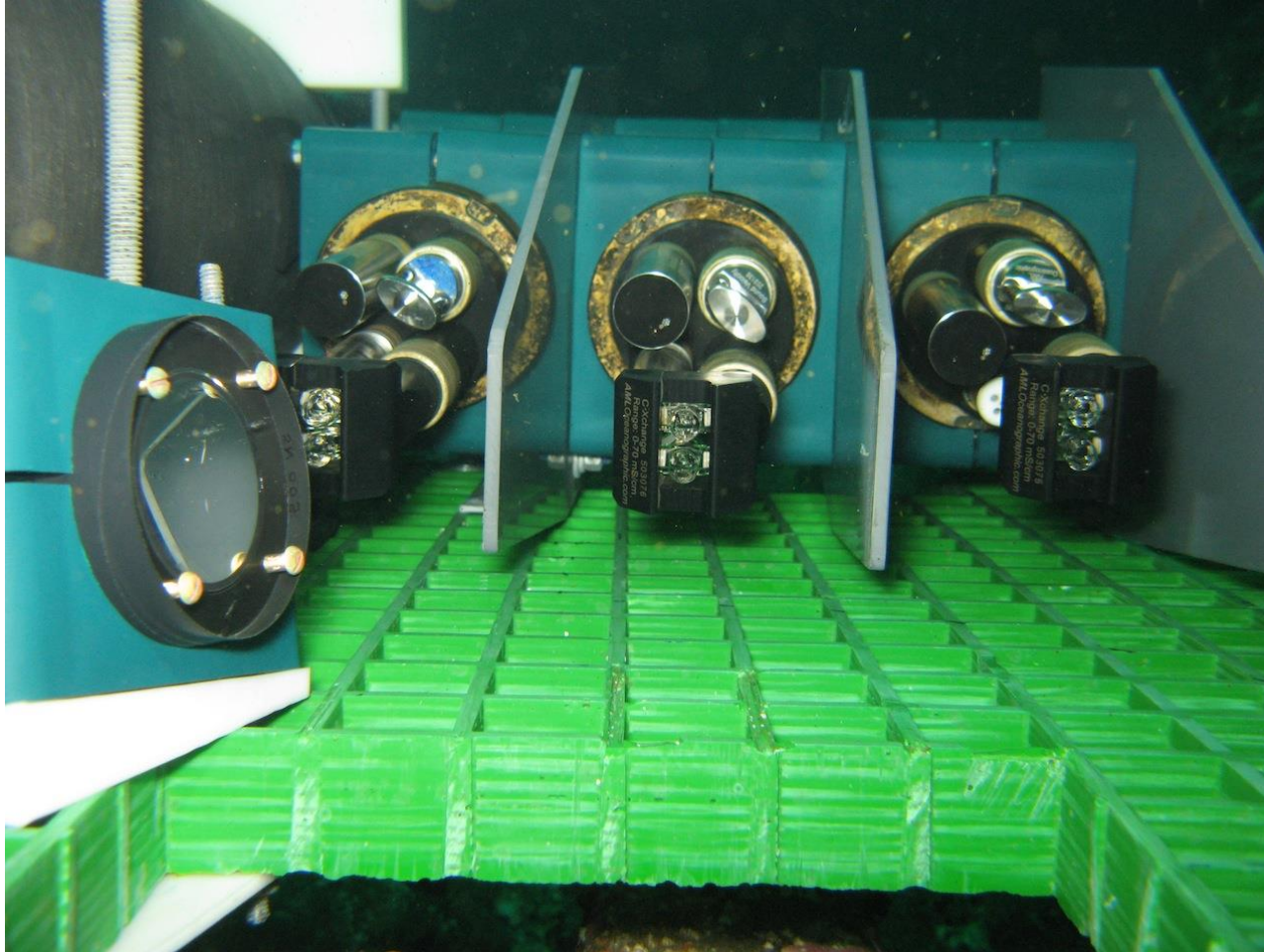

2071 Malaview Avenue Sidney, British Columbia Canada, V8L 5X6



After 9 months



2071 Malaview Avenue Sidney, British Columbia Canada, V8L 5X6

After 26 months – final in situ video



2071 Malaview Avenue Sidney, British Columbia Canada, V8L 5X6

ONC Testimonial

“after 15 months and still going, at our worst biofouling site, the sensors remain clean and operating fine. We are absolutely amazed”

Scott McLean, Director
Ocean Network of Canada



Case2 - US Ocean Observatories Initiative (OSU+UW/WHOI)

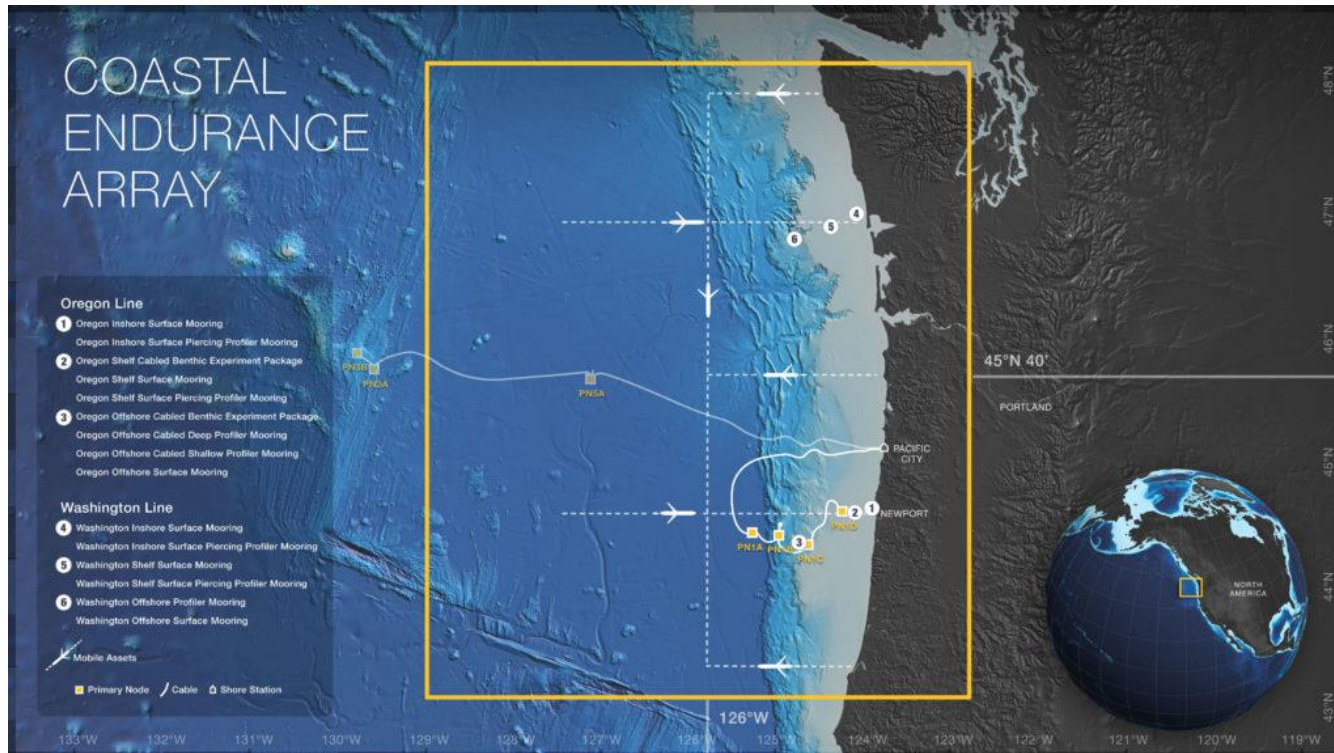

Case2 - US Ocean Observatories Initiative (OSU+UW 1+20)

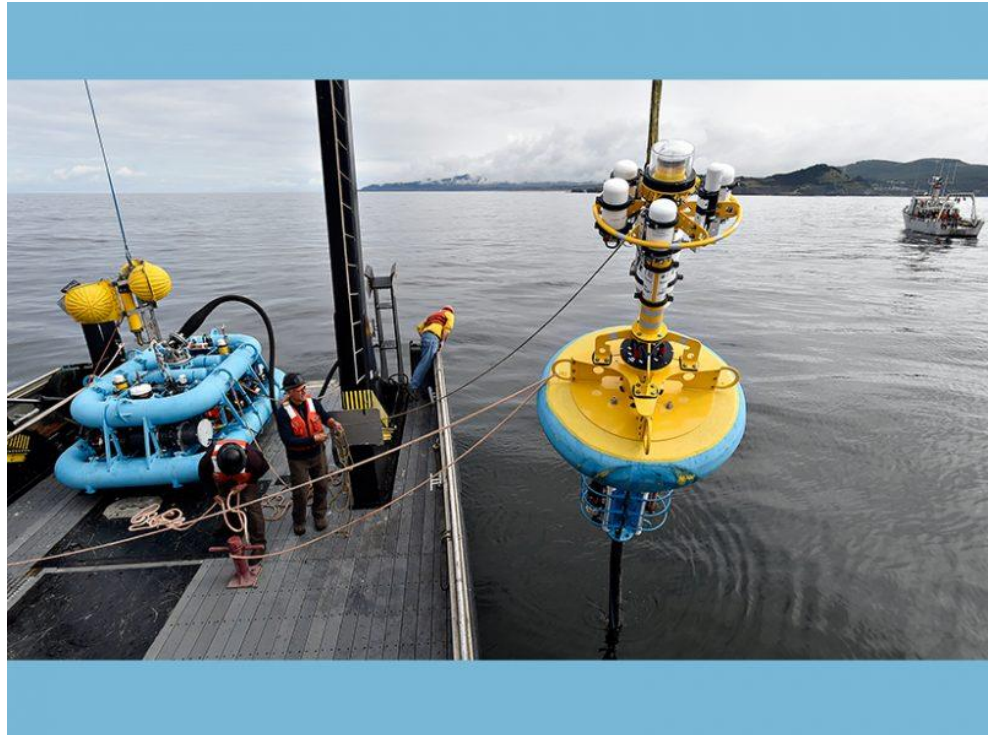
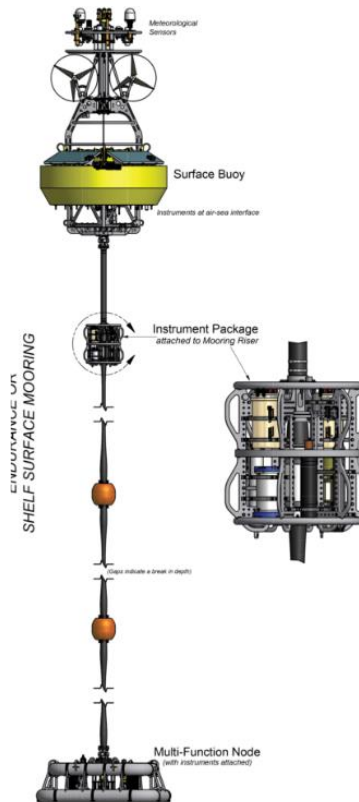

Case2 - US Ocean Observatories Initiative (OSU+UW)



OSU Testimonial

“

Each cruise is expensive, so we need instruments deployed in the photic zone to last the full six months without significant fouling. Six weeks into our test, the unprotected oxygen sensor was clearly fouled while the UV protected sensor is still producing reasonable data. We intend to deploy the UV device with all of our upper water column oxygen sensors in the future, and will experiment with the UV light on our other optical instruments.

Jonathan Fram

Assistant Professor, Oregon State University



Case3 - DSO National Laboratories Singapore (1+9)



“Our test for UV results showed the performance of your UV lights is excellent.”

Peiyuan Huang, researcher

Case4 - Hawaii Institute of Marine Biology

4 Metrec X (CTD, DO, Tu, pH and Par) to for scientist to understand the reef ecosystem in Hawaii. “UV biofouling will be the critical factor in successfully recording a long term series of values to assess the reef system. “



Richard Pyle

Case5 – Guangxi Reef Monitoring 广西珊瑚礁生态在线监测系统

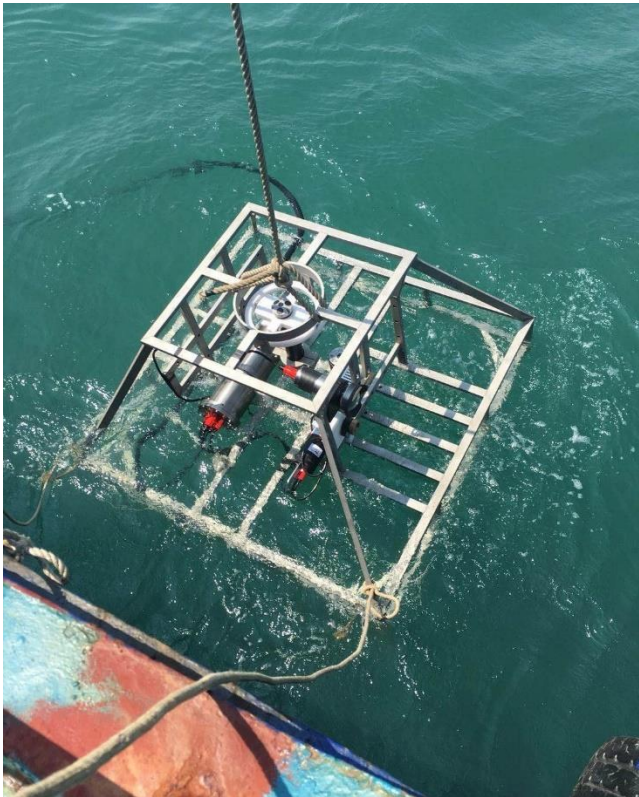

Case5 – Ocean Farm 海洋牧场在线监测



Other customer successes

- China
- HURL
- IOW
- Dubai
- Kuwait
- Netherlands
- Australia
- Canada



What we are known for

- Sound velocity probes and profilers
 - Time-of-Flight SV
 - Fast-response CTD
- CTD, turbidity, and other parameter sensing for vertical profiling or in-situ deployment
 - Environmental monitoring / science and research
- Swappable Sensors (Xchange)
- UV•Xchange and Cabled UV Biofouling Control



Xchange™ Sensor Heads

Turbidity•Xchange™, T•Xchange™, SV•Xchange™, P•Xchange™,
C•Xchange™, CT•Xchange™, pH, Fluorescence



AML Metrec X



Publications

- Journal of Ocean Technology: The Influence of Light, Feb. 2015
- Marine Technology Reporter: It's Time to Think in Years, Mar. 2015
- Marine Technology Reporter: Biofouling Foiled, Sept. 2014
- Ocean News & Technology: A New Kind of Antifoulant, Jan. 2014
- ECO: Any Surface Foul Free, May 2014

Underway multi-parameter real-time observation Moving Vessel Profiler (MVP)

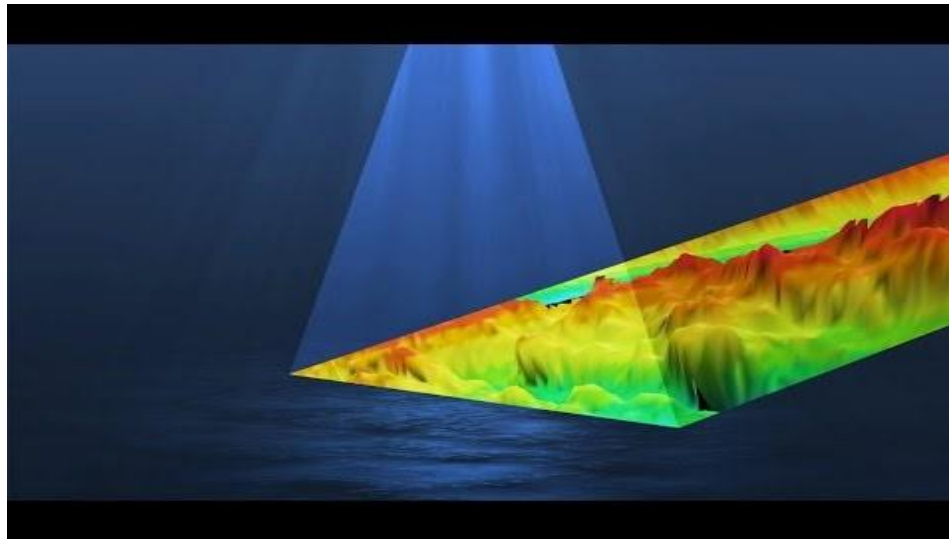

Underway multi-parameter real-time observation Moving Vessel Profiler (MVP)

MVP-200 operating in Seastate 7

Deploying to ~ 100m every 30 minutes at 8 knots



500 profiles in 12 days
each profile equivalent to
~ 0.5 hours stationary
(ship cost ~ US\$1000 per hour)

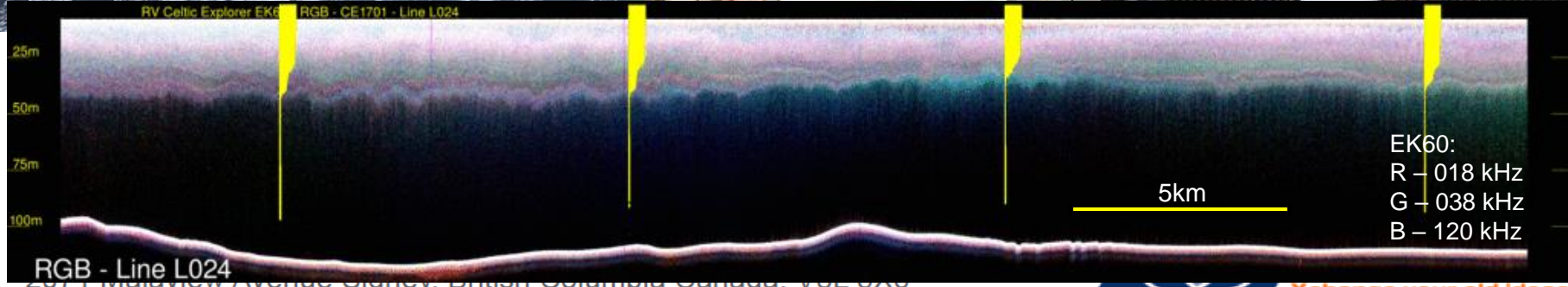

2911 Midview Avenue Sidney, British Columbia Canada, V6E 0X6

Multi-sensor options



Pacific Location: 2071-A Malaview Avenue, Sidney, British Columbia, CANADA V8L 5X6
 Atlantic Location: 800A Windmill Road, Unit 6C, Dartmouth, Nova Scotia, CANADA, B3B 1L1
 Office: +1.250.656.0771
 E-Mail: sales@amloceanographic.com



Sensors which have been integrated into the MVP System for use with the Multi-Sensor Free Fall Fish (MSFFF)

Sensor / Instrument Options Available

Item	Description	
	Serial Sensors	Analog (0-5V) Sensors
1	AML CTD	Wetlabs ECO Fluorometer
2	AML SVP&T	Seapoint Fluorescein Fluorometer
3	SBE49	Turner Cyclops7 Fluorometer
4	AML Micro P (Pressure)	Turner Cyclops7 Crude Oil Sensor
5		Rinko III Dissolved Oxygen
6		Seapoint Turbidity
7		Seapoint Chlorophyll Fluorometer
8		WET Labs (red) C-STAR transmissometer
9		SBE43 Dissolved Oxygen
10		D&A OBS

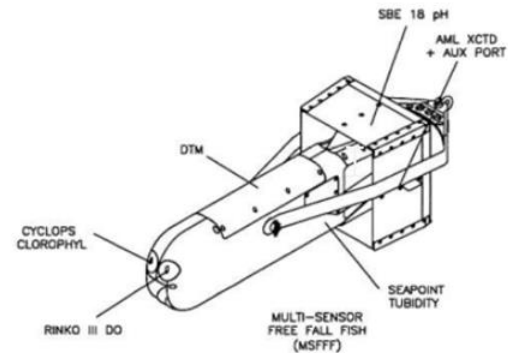

Underway multi-parameter real-time observation

HOW IS MVP UNIQUE?

	MVP	Other Underway Profilers *	XBTs	Static Profilers
Real-time Data	✓	✗	✓	Some
High Density Data	✓	✓	✓	✗
Continuous Profiling	✓	✓	✗	✗
Full Water Column Coverage	✓	✗	✓	✓
Multiparameter Data	✓	✗	✗	✓
Military Grade	✓	✗	✓	✓
Automated Bottom Tracking	✓	✗	✗	✗

* vertical profiles

Trusted by most prestigious ocean research institutes around the world



**National Oceanography
Centre Southampton**
UNIVERSITY OF SOUTHAMPTON AND
NATURAL ENVIRONMENT RESEARCH COUNCIL



What AML can offer

- UV biofouling control to remove both financial and technical uncertainty in long-term in-situ deployment and maintain data integrity.
- Multi-parameter real-time instruments (up to 9 sensors) with independently calibrated exchangeable sensors (CTD, Tu, DO, pH, CDOM, Par, Chlorophyll A, etc.) to fulfill cross-discipline ocean data needs
- We bring calibration to you - annual calibration services
- Expertise and experience working with cabled ocean observatory networks and research vessels.

Contact information

微信: jackieguo2014

Thank You!

2071 Malaview Avenue Sidney, British Columbia Canada, V8L 5X6

